



Ø120

Pies Gripper con Rótula

en polipropileno reforzado

-  Best Seller
-  Standard
-  A petición

Part. R0628

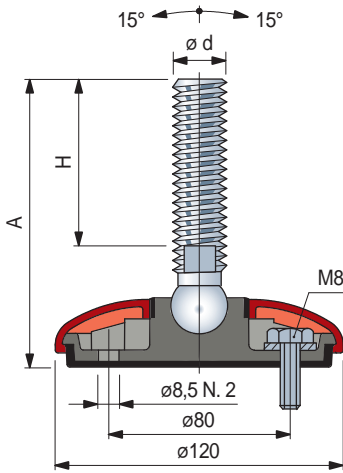

Tapa de protección

Color	Code
Naranja	R0628643092
Negro	R0628643102



- Material: polipropileno PP.
- Confección: 24 piezas.

Accesorios

Tuerca + Arandela

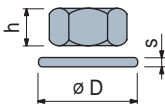

	Code					
	Acero Inox AISI 304	Acero zincado	h mm	 øD mm	s mm	
M14	R0000630202	R0000630132	11	22	28	2,5
M16	R0000630212	R0000630142	13	24	30	3
M20	R0000630222	R0000630152	16	30	37	3
M24	R0000630232	R0000630162	19	36	44	4

Confección: 8 piezas.

Tipo de espárrago

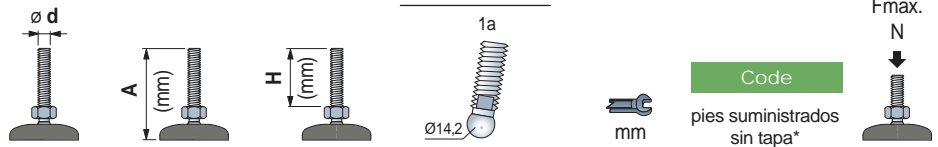

Espárrago en acero inoxidable					
M14	120	76	1a	11	643802
	110	64	1a	13	643812
	125	81	1a	13	643822
M16	155	100	1a	13	642472N
	170	124	1a	13	643832
	195	151	1a	13	643842
	205	150	1a	13	642512N
M20	130	84	1a	16	643852
	195	149	1a	16	643862
M24	125	74	1a	19	642572N
	195	146	1a	19	643872
	225	172	1a	19	642592N

22000

Espárrago en acero zincado					
M14	100	56	1a	11	643882
	105	61	1a	13	643892
M16	140	96	1a	13	643902
	160	116	1a	13	643912
	195	151	1a	13	643922
M20	125	74	1a	16	642692N
	145	100	1a	16	643932
	160	106	1a	16	642712N
	195	150	1a	16	643942
M24	260	214	1a	16	643952
	130	81	1a	19	643962
	195	146	1a	19	643972

22000

Código para pedido = Part. + Code

- * = Los pies son entregados sin la tapa de protección. Ordenar la tapa a parte, eligiendo el color deseado.
- Material de la base: polipropileno reforzado con antideslizante integrado en goma termoplástica gris (dureza 70 Shore).
- El sellado de la estructura interna garantiza la esterilización.
- El pie está predispuesto para una eventual fijación al suelo.
- Confección: 24 piezas.
- Largos diferentes bajo pedido.
- Fmax. = carga maxima aplicable en condiciones estáticas.