

Pies con Rótula

en acero inoxidable

✓ Best Seller

✓ Standard

● A petición

Part. R0747

Part. R0748

Part. R0747

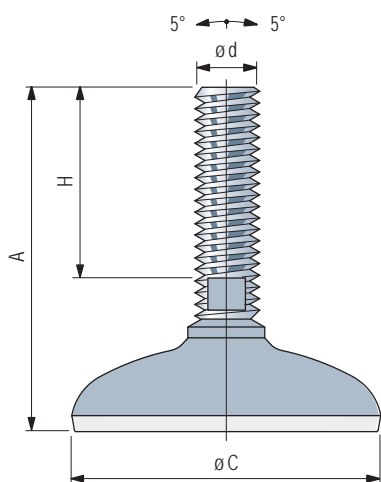

Part. R0747

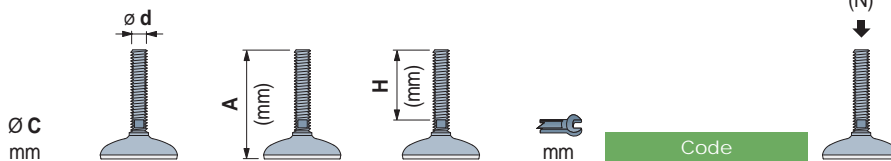

Espárrago en acero inoxidable

	M16	100	55	13	602003
		182	136	13	602013
	M20	187	139	16	602023
	M24	217	167	19	602033
	M30	165	115	27	620793
		215	165	27	620803

25000

Part. R0748

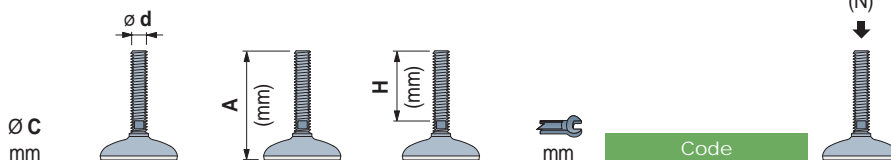

Espárrago en acero inoxidable

	M16	103	55	13	602043
		185	136	13	602053
	M20	190	139	16	602063
	M24	220	167	19	602073
	M30	168	115	27	620813
		218	165	27	620823

25000

Part. R0749

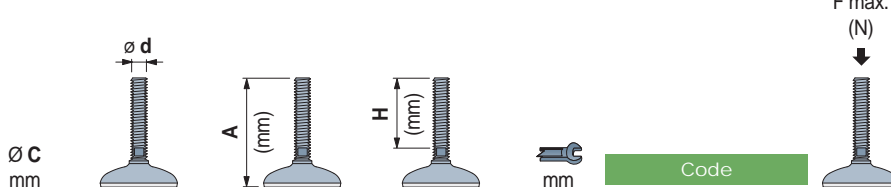

Espárrago en acero inoxidable

	M16	190	136	13	602093
	M20	195	139	16	602103
	M24	225	167	19	602113
		173	115	27	620833
	M30	223	165	27	620843
		250	200	27	616433
M36	265	216	32	628033	

25000
50000

Código para pedido = Part. + Code

- Material:

Ésparrago en acero inoxidable austenítico.

Base en acero inoxidable austenítico.

Antideslizante en goma vulcanizada NBR (gris), 75 Shore;

Part R0749616433 - R0749628033 antideslizante en goma vulcanizada NBR (negra), 95 Shore.

- Confección: 8 piezas.

- Largos diferentes bajo pedido.

- Fmax. = carga máxima aplicable en condiciones estáticas.

Accesorios

Tuerca + Arandela

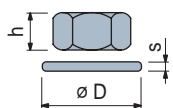

Code

	Acero Inox AISI 304	h mm	øD mm	s mm
M16	R0000630212	13	24	30
M20	R0000630222	16	30	37
M24	R0000630232	19	36	44
M30	R0000630242	24	46	56

Confección: 8 piezas.