

# Perfiles Guía - Cadena

## • Patín derecho Dx

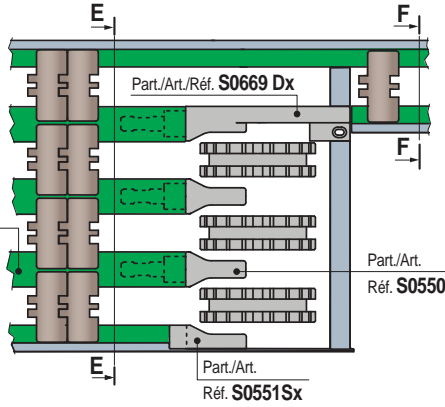

## • Patín izquierdo Sx

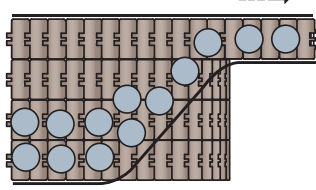
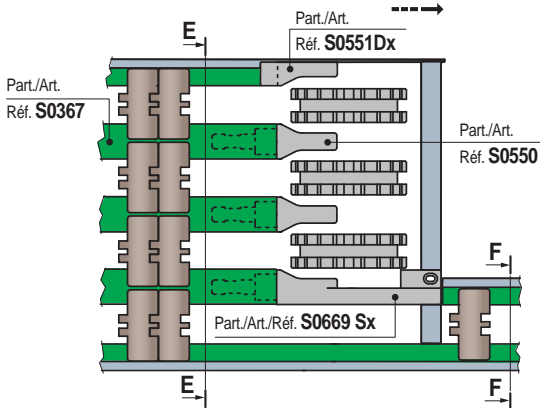
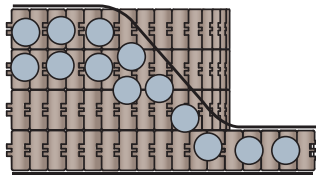

## ■ Patín para guía-cadena

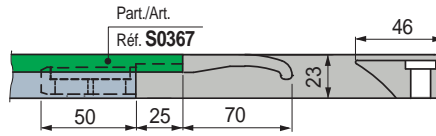

### Versión derecho Dx

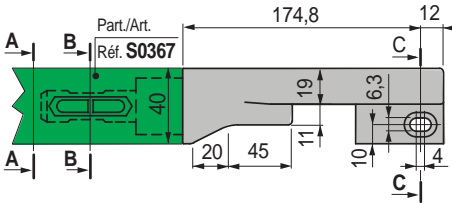

### Versión izquierdo Sx

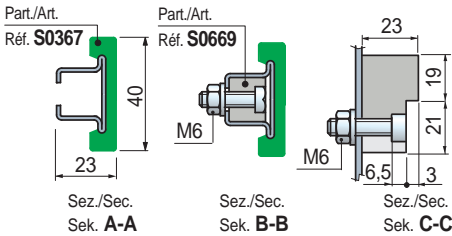
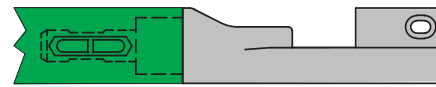

Material	Versión	Code	Peso kg
Poliamida PA (negra)	Derecho Dx	674212	0,1
	Izquierdo Sx	674222	

- Aplicación: guía la cadena en los desplazamientos laterales.
- Envase: 10 unidades.

### • Posición

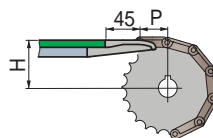

P = Paso cadena.  
H = Ver pàg. S213.

Part. S0669



## • Cadenas TableTop® con bisagra individual Serie 812 - 815 - 820 - 831 - 881TAB - 8811TAB - 879TAB - 880TAB.

Anchura cadena 82,5 mm (K 325) / paso 83,5 mm

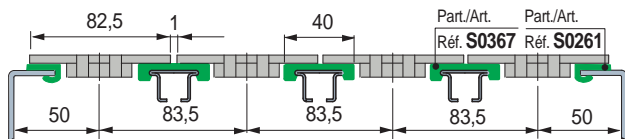

Sez./Sec.  
Sek. E-E

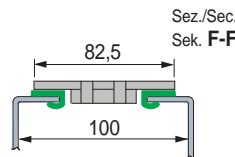

Sez./Sec.  
Sek. F-F

Anchura cadena 82,5 (K325) mm (K 325) - 83,8 mm (K 330) / paso 85 mm

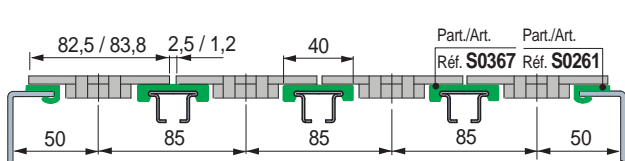

Sez./Sec.  
Sek. E-E

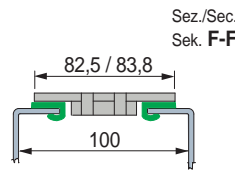

Sez./Sec.  
Sek. F-F

Cadena MatTop® métrica Serie 7705 M

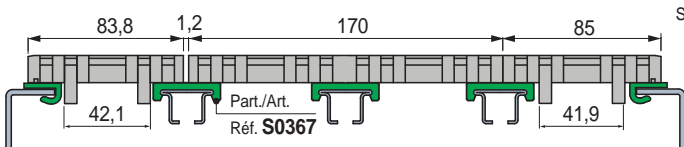

Sez./Sec.  
Sek. E-E

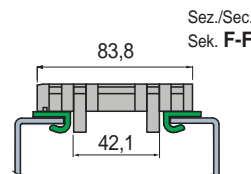

Sez./Sec.  
Sek. F-F

● Best Seller

● Standard

● A petición: cantidad mínima requerida. Consulte a nuestro Customer Service para conocer la disponibilidad.

Código para pedido = Part. + Code