

## Part. S0073

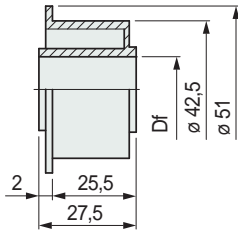

Ø 42,5 mm

### ■ Rodillo



Ø eje mm	Ø agujero Df mm	Code
12	12,5	50660
16	16,5	62946
18	18,5	50670
20	20,5	50680

- Material: polietileno PE (negro).  
- Confección: 100 piezas.

## Part. S0126



### ■ Distanciador

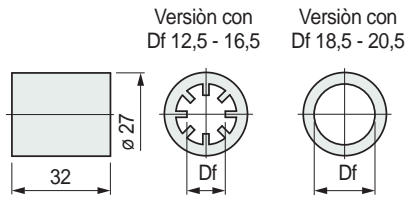

Ø eje mm	Ø agujero Df mm	Code
12	12,5	65396
16	16,5	65406
18	18,5	65416
20	20,5	62520

- Material: polietileno PE (negro).  
- Confección: 100 piezas.

## Part. S0125



Ø 42,5 mm

### ■ Rodillo doble L55

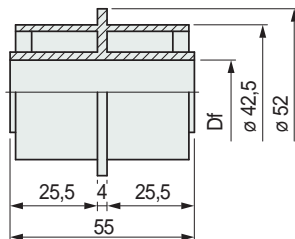

Ø eje mm	Ø agujero Df mm	Code
12	12,5	62956
16	16,5	62966
18	18,5	62976
20	20,5	62510

- Material: polietileno PE (negro).  
- Confección: 100 piezas.

Código para pedido = Part. + Code

### • Cadenas de bisagra TableTop® / Cadenas PlateTop

Ancho cadena 82,5 mm (K 325)

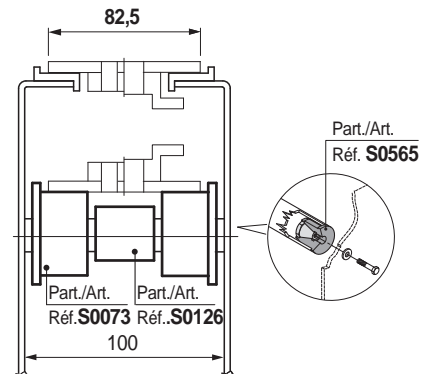

Ancho cadena 114,3 mm (K 450)

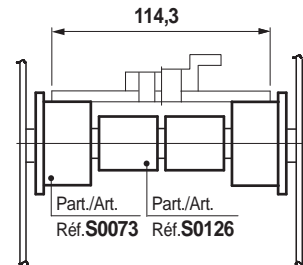

Ancho cadena 82,5 mm (K 325) / paso 88 mm

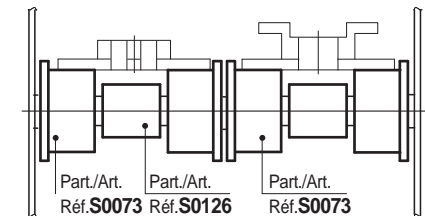
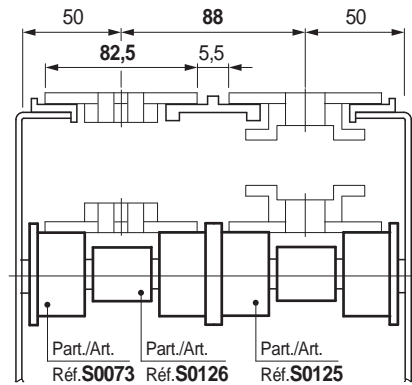

Ancho cadena 114,3 mm (K 450) / paso 120 mm

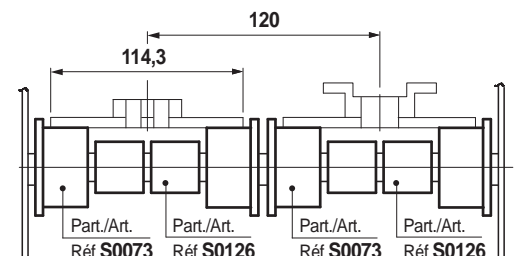

● Best Seller

● Standard

● A petición: cantidad mínima requerida. Consulte a nuestro Customer Service para conocer la disponibilidad.