

# Mordazas Porta - Guías

para Perfiles Redondo de acero

• Montaje Part. S0698

Fijación sobre barras aplanadas

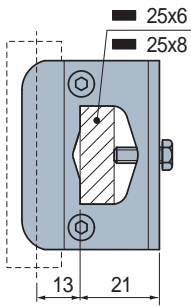

Fijación sobre tubos redondos

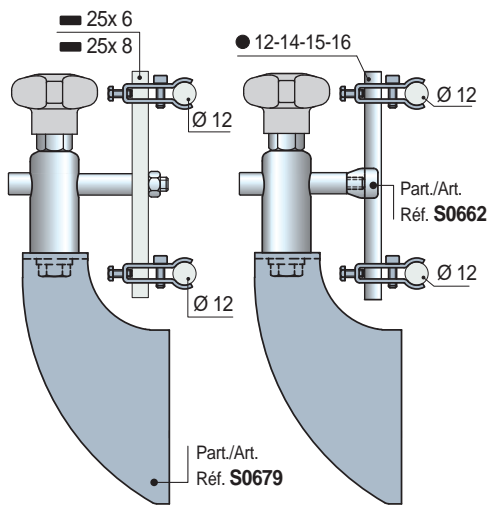
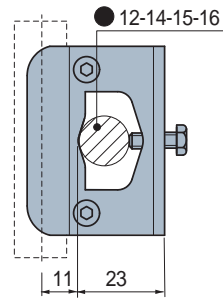

• Montaje Part. S0662

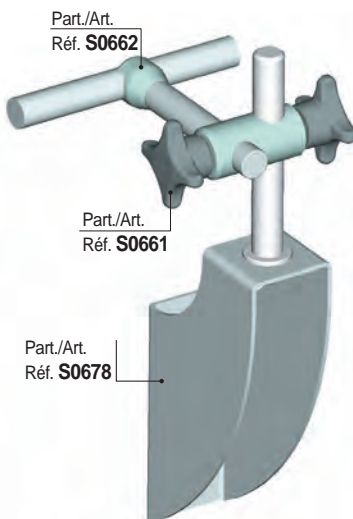

■ Mordaza porta-guías

Con 2 tornillos de fijación

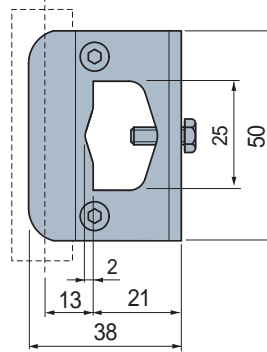
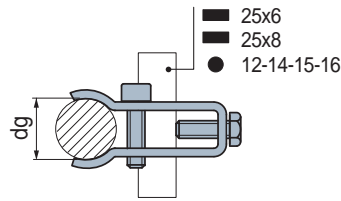

Ø guía d mm	Code	Peso kg
12	689202	0,10

- Material: mordaza y penería de acero inoxidable austenítico.
- Confección: 16 unidades.

Part. S0698



■ Mordaza porta-guías

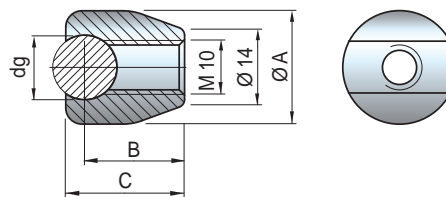

Ø redondo dg mm	Code	Ø A mm	B mm	C mm	Peso kg
10	669542	20	17,5	20	0,03
12	669552	21	18,5	22	
14	669562	23	19,5	24	

- Material: acero inoxidable austenítico.
- Confección: 50 piezas.

Part. S0662



● Best Seller

● Standard

● A petición: cantidad mínima requerida. Consulte a nuestro Customer Service para conocer la disponibilidad.

Código para pedido = Part. + Code